

# OPTICAL MOUSE SENSOR

NST TECHNOLOGIES

## M16xxx Series Datasheet

USB INTERFACE

Version 1.16

---

## 1. Description

M16175 is a low-cost CMOS optical sensor SOC for USB optical computer mouse. It provides an all-in-one solution including controller and sensor.

M16175 is based on algorithm which measures changes of sequential surface images and then determines the movement. It has 1000 DPI resolution and it's max motion speed can reach 24 inches per second and it's max acceleration can reach 20g.

M16175 is in a 12-pin optical DIP package and provides full mouse function including three buttons, X-Y motion and Z axis wheel. It has a built-in LED driver and internal oscillator to minimize the external components.

M16175 is a USB interface SOC sensor and has completely USB HID ver1.1 compatibility. It is compatible with Microsoft 3D IntelliMouse.

## 2. Feature

- 5.0 V power supply
- USB interface
- L/M/L three buttons
- X/Y/Z three axis
- 1000 DPI solution
- 3000 frame/second
- Max speed 24 inch/second
- Support windows OS , including WIN7, Vista, 2000, XP, ME and 98
- Low speed USB1.1 compatibility
- Movement Algorithm technology
- Built-in LED driver
- Built-in oscillator
- Minimal number of external components

## 3. Application

- Computer mice for desktop PCs, workstation and portable computers
- Integrated input devices

## 4. Pin Configuration

### 4.1 Pin Assignment

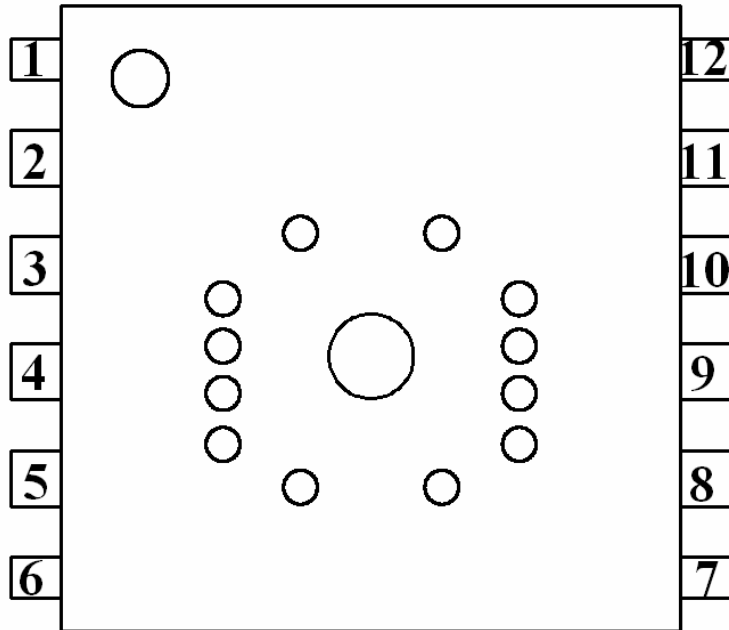

Figure 1. Top View Pinout

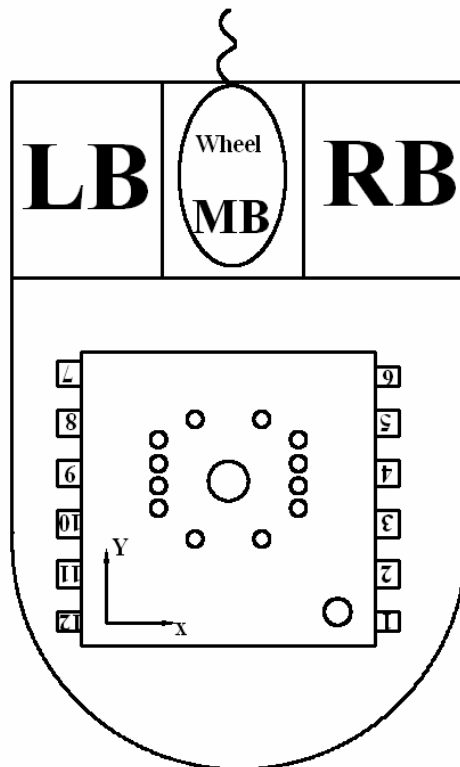
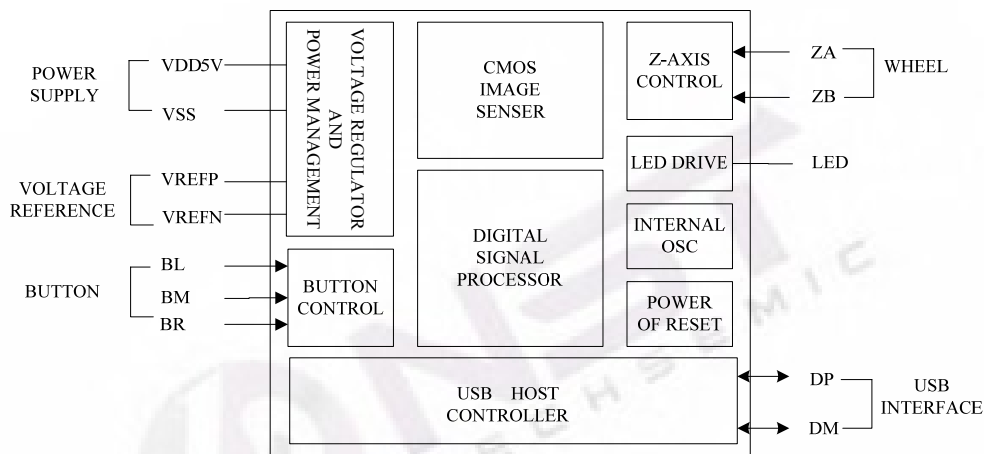

Figure 2. Top View of Mouse

## 4.2 Pin Description

Pin	Name	Direction	Description
1	VDD33		Analog voltage reference
2	RB	INPUT	Right button input
3	MB	INPUT	Middle button input
4	LB	INPUT	Left button input
5	LED	OUTPUT	LED driver output
6	LEDVSS		LED driver ground
7	DP	I/O	USB interface D+
8	DM	I/O	USB interface D-
9	ZB	INPUT	Z axis inputB
10	ZA	INPUT	Z axis inputA
11	VDD		Power supply, 4.5V~5.5V
12	GND		System ground

## 5. Block Diagram and Operation



**Figure 3. Block Diagram**

M16175 is a CMOS process optical mouse sensor single chip which embedded USB controller and non-mechanical motion estimation module. It is in a 12-pin optical DIP package and provides full mouse function including three buttons, X-Y motion and Z axis wheel. It has a built-in LED driver and internal oscillator to minimize the external components

## 6. Electrical Characteristics

Absolute Maximum Ratings					
Parameter	Symbol	Min	Max	Units	Notes
Supply voltage	VDD	-0.5	5.5	V	
Operating Temperature	T <sub>O</sub>	-15	+55	°C	
Storage Temperature	T <sub>S</sub>	-40	+85	°C	
Lead Solder Temp			260	°C	
Input voltage	V <sub>IN</sub>	-0.5	5.5	V	
ESD	V <sub>ESD</sub>	2		kV	All pins, human body model, MIL STD 883G method 3015.7

Recommend Operating Conditions						
Parameter	Symbol	Min	Typical	Max	Units	Notes
Supply Voltage	VDD	4.5	5.0	5.5	V	
Operating Temperature	T <sub>A</sub>	0	25	40	°C	
Distance from lens reference plane to surface	Z	2.2	2.3	2.4	mm	
System clock	CLK	22	24	26	MHz	
Speed	S	-	-	24	Inch/Sec	
resolution	R	-	1000	-	DPI	

DC Electrical Specifications (VDD = 5.0V, Temperature = 25°C )						
Parameter	Symbol	Min	Typical	Max	Units	Notes
Supply current (in motion)	I <sub>DD</sub>	-	16.5	-	mA	
Supply current (no motion)	I <sub>DD1</sub>	-	7.8	-	mA	
Input voltage High (input port)	V <sub>IH1</sub>	2.0	-	-	V	
Input voltage Low (input port)	V <sub>IL1</sub>	-	-	0.8	V	
Input voltage High (I/O port)	V <sub>IH2</sub>	2.0	-	-	V	
Input voltage Low (I/O port)	V <sub>IL2</sub>	-	-	0.8	V	
Output voltage High (I/O port)	V <sub>OH1</sub>	2.8	-	3.6	V	
Output voltage Low (I/O port)	V <sub>OL1</sub>	0	-	0.3	V	

AC Electrical Specifications (VDD = 5.0V, Temperature = 25°C )						
Parameter	Symbol	Min	Typical	Max	Units	Notes
Power up delay	T <sub>PU</sub>	-	10	-	us	POR signal from 0 to 3.5
Debounce time on button	T <sub>DB</sub>	9.5	11.5	13.5	ms	
Z wheel sampling period	T <sub>Z</sub>	-	125	-	us	

### 7. Sensor pixels array mapping

306	307	308	309	310	311	312	313	314	315	316	317	318	319	320	321	322	323
288	289	290	291	292	293	294	295	296	297	298	299	300	301	302	303	304	305
270	271	272	273	274	275	276	277	278	279	280	281	282	283	284	285	286	287
252	253	254	255	256	257	258	259	260	261	262	263	264	265	266	267	268	269
234	235	236	237	238	239	240	241	242	243	244	245	246	247	248	249	250	251
216	217	218	219	220	221	222	223	224	225	226	227	228	229	230	231	232	233
198	199	200	201	202	203	204	205	206	207	208	209	210	211	212	213	214	215
180	181	182	183	184	185	186	187	188	189	190	191	192	193	194	195	196	197
162	163	164	165	166	167	168	169	170	171	172	173	174	175	176	177	178	179
144	145	146	147	148	149	150	151	152	153	154	155	156	157	158	159	160	161
126	127	128	129	130	131	132	133	134	135	136	137	138	139	140	141	142	143
108	109	110	111	112	113	114	115	116	117	118	119	120	121	122	123	124	125
90	91	92	93	94	95	96	97	98	99	100	101	102	103	104	105	106	107
72	73	74	75	76	77	78	79	80	81	82	83	84	85	86	87	88	89
54	55	56	57	58	59	60	61	62	63	64	65	66	67	68	69	70	71
36	37	38	39	40	41	42	43	44	45	46	47	48	49	50	51	51	53
18	19	20	21	22	23	24	25	26	27	28	29	30	31	32	33	34	35
0	1	2	3	4	5	6	7	8	9	10	11	12	13	14	15	16	17

Figure 4. Sensor pixels array mapping

### 8. PCB Assembly

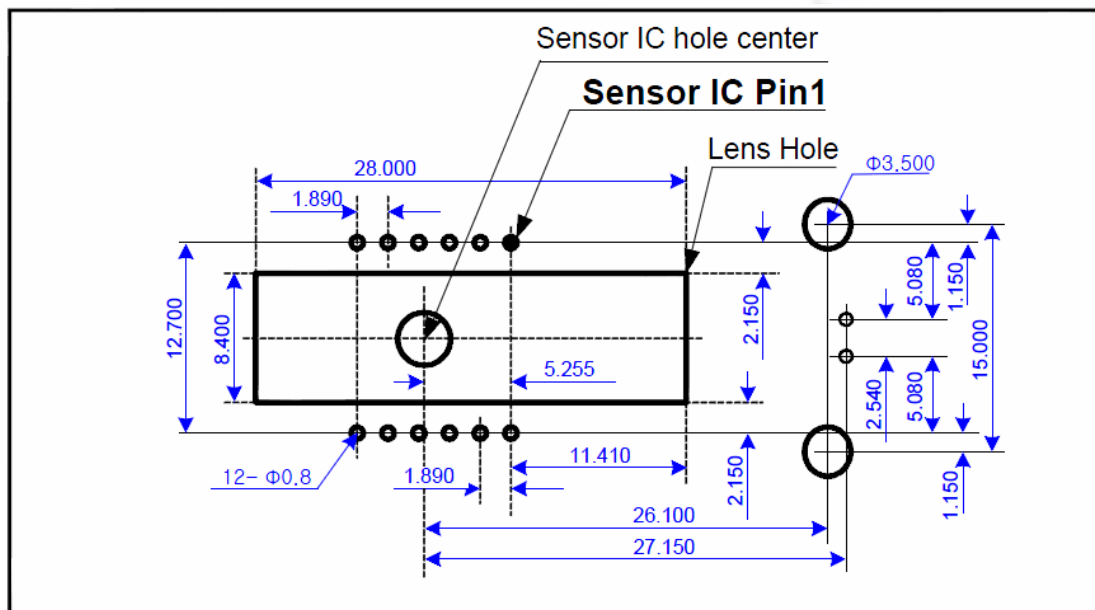

Figure 5. Recommended PCB Mechanical Drawing (Unit: mm)

## 9. Assembly Drawing (Unit: mm)

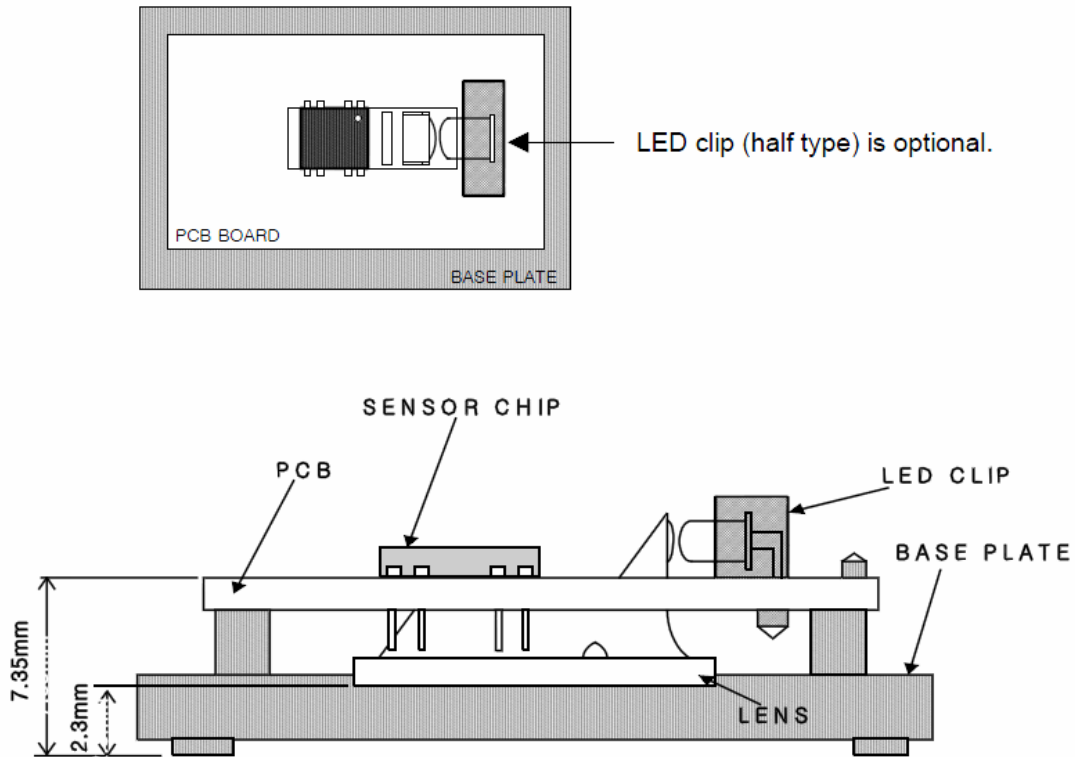

Figure 6. Assembly Drawing

## 10. Application Circuit

### 10.1 Typical application

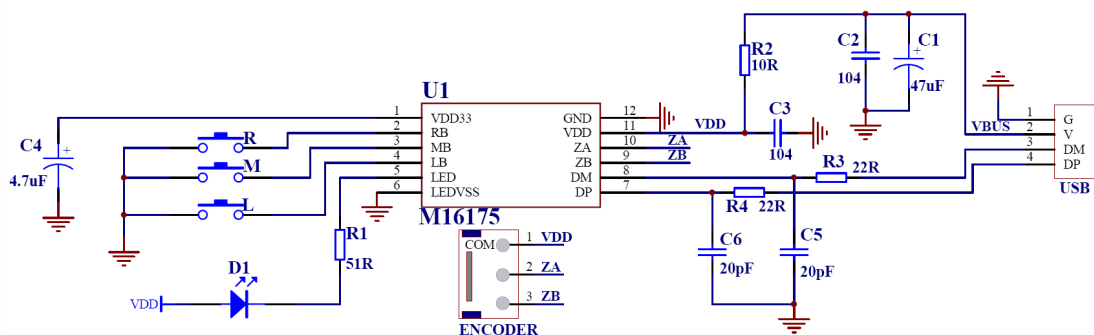

Figure 7. Typical 3D3K USB optical mice application.

#### Notes:

1. For EMC immunity option components: R2, R3, R4, C5, C6.
2. Connector J1 is suggested to have the pin sequence like: DP, DM, Shield, GND, VBUS.

Figure 7 shows the recommended application circuit to customer. It will provide better EMI characteristic. When PCB Layout, C3, C4 should be closed to chip.

All rights strictly reserved any portion in this paper shall not be reproduced, copied or transformed to any other forms without permission.

## 10.2 Tidy application

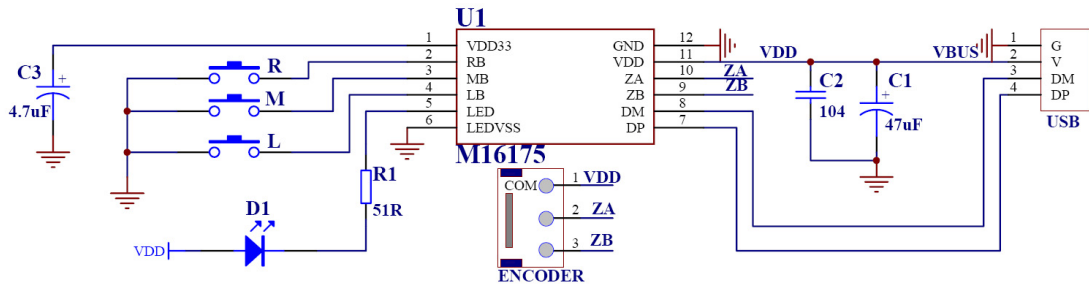

**Figure 8. Tidy 3D3K USB optical mice application.**

Figure8 shows a application circuit that need less external components than figure1 . But it still can work well for mouse function . When PCB Layout,C3 should be closed to chip.

## 11. Package Information

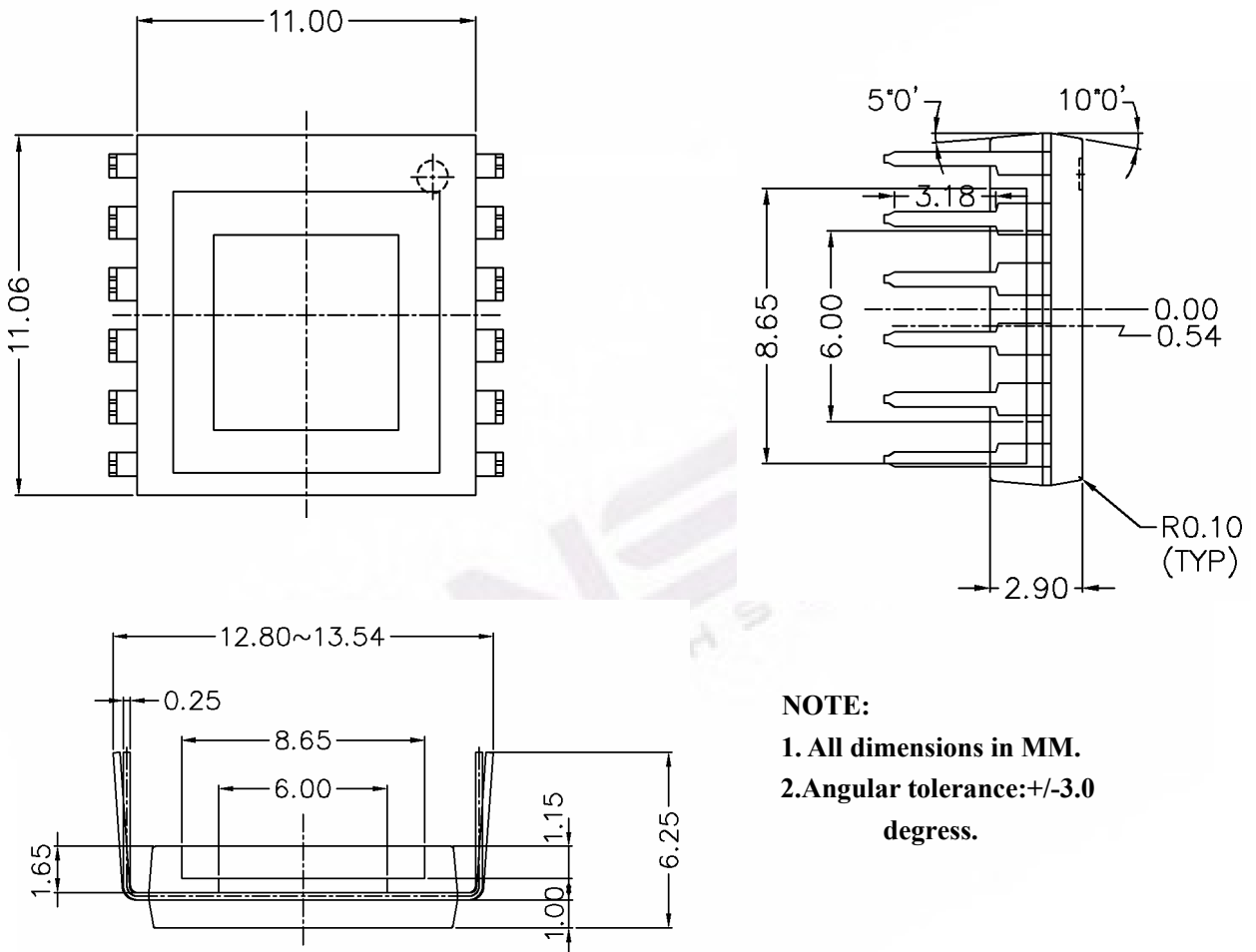

**Figure 9. Package Information**

All rights strictly reserved any portion in this paper shall not be reproduced, copied or transformed to any other forms without permission.



---

## 12. Version History

Version	Description	Date
M16175_V1.13	Create the preliminary version	2010/03/18
M16175_V1.14	Add EMI Application Schematic	2012/04/08
M16175_V1.15	Change Led current-limiting resistance 68R to 51R	2012/08/15